

v1.0

# BROSA

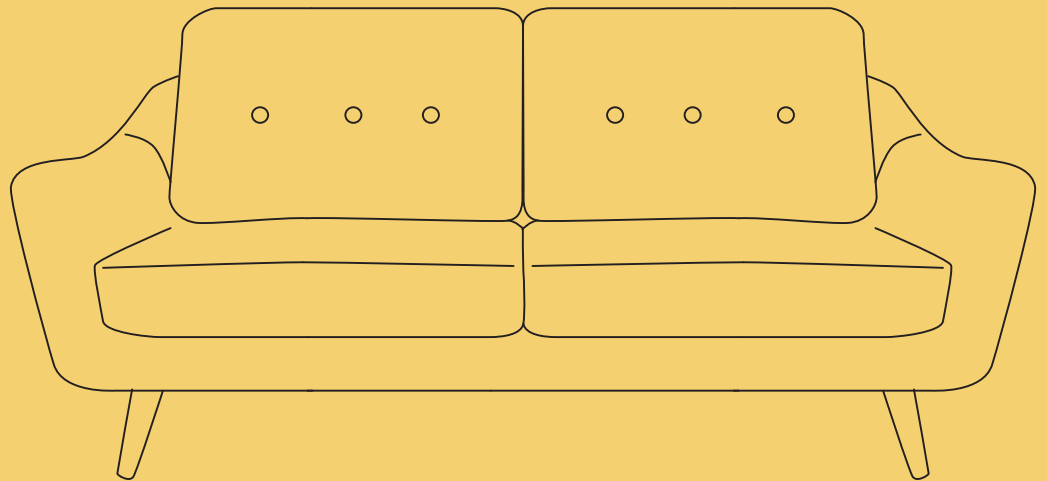

**ASSEMBLY GUIDE**

## Eva 3 Seater Sofa

# Components

Upon unpacking your sofa from its delivery box, you should have the separate pieces shown below. Follow the steps on the next pages to assemble your new sofa.

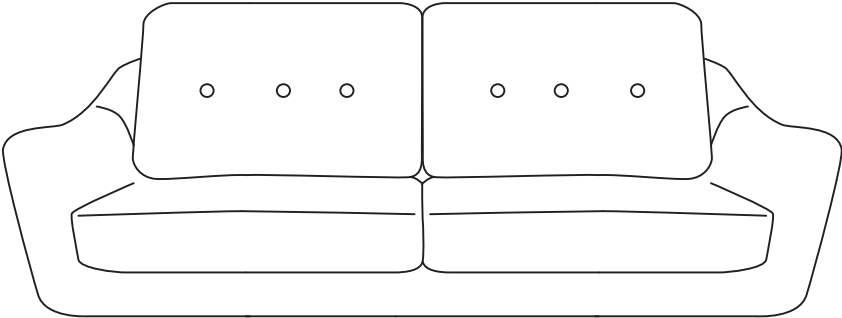

Body x 1

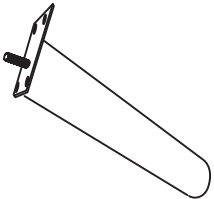

A x 4 (Leg)

## Hardware



B x 16 (Bolt)



C x 1 (Allen Key)

## What you need

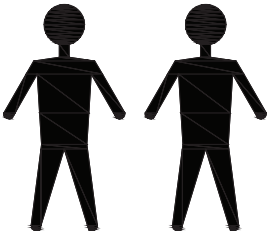

# Step 1

Screw the leg (A) tightly in so that in the end the four holes are aligned with the holes on the body and the leg is toward outside. Repeat for all four legs.

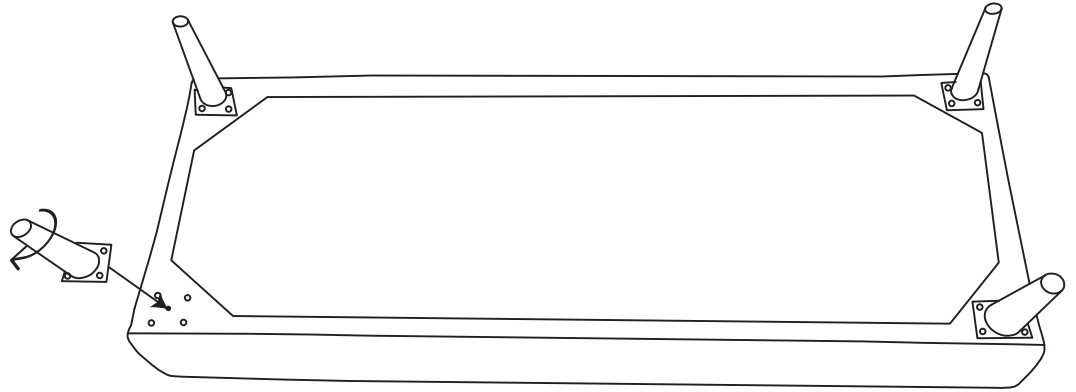
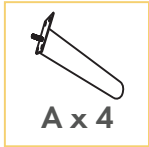

# Step 2

Align a bolt (B) to a hole. Turn the bolt with the allen key (C) until it is secure but do not tighten yet. Repeat for all four bolts then tighten them. Repeat for remaining legs.

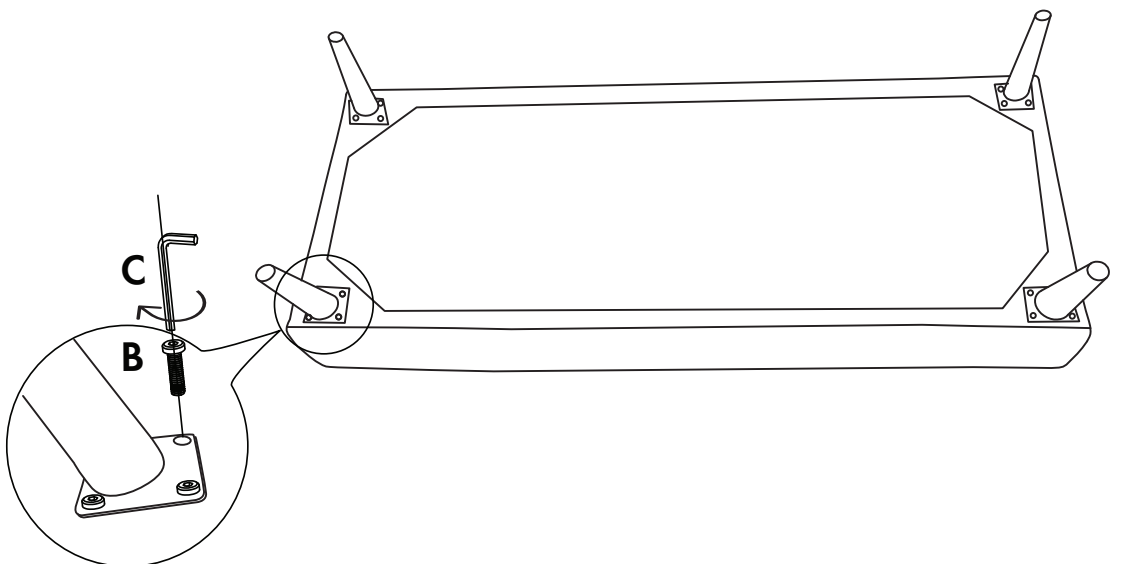
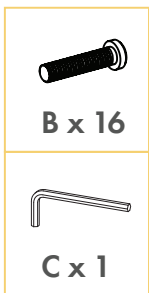

# Step 3

Place the sofa on a flat surface and enjoy your new sofa!

