

v1.0

BROSA

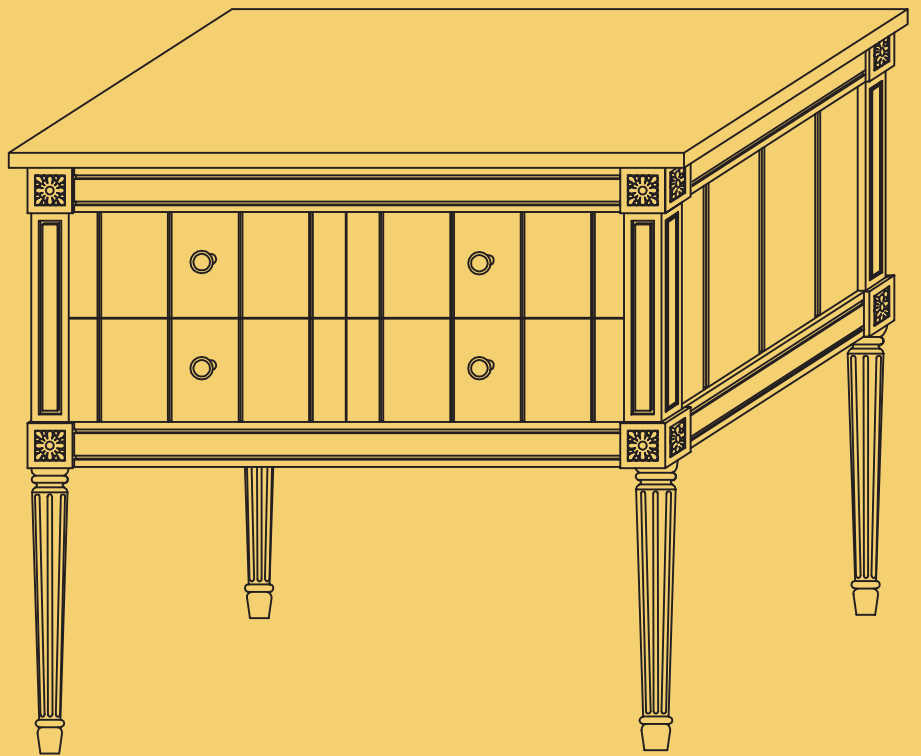

ASSEMBLY GUIDE

Rochefort Vintage Cabinet

Components

Upon unpacking your storage from its delivery box, you should have the separate pieces shown below. Follow the steps on the next pages to assemble your new storage.

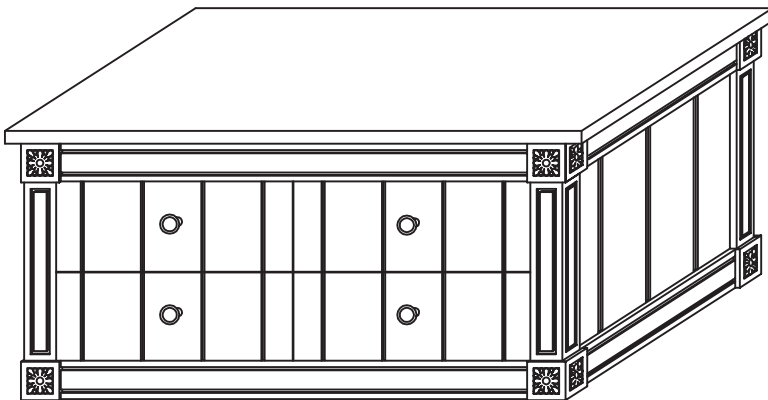

Body x 1

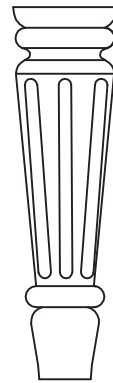

Leg x 4

Hardware

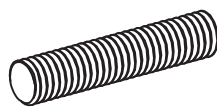

A x 4 (Threaded Bolt)
Spec: 8x50mm

What you need

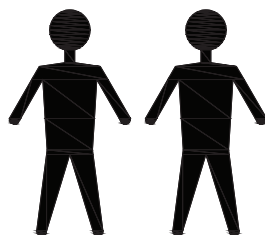

Step 1

Screw the threaded bolt (A) halfway into the corner opening under the body. Screw the leg to the bolt until tight. Repeat for all four legs.

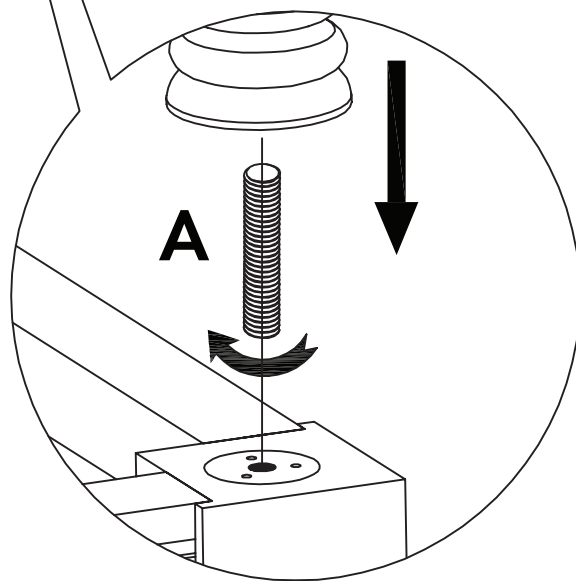
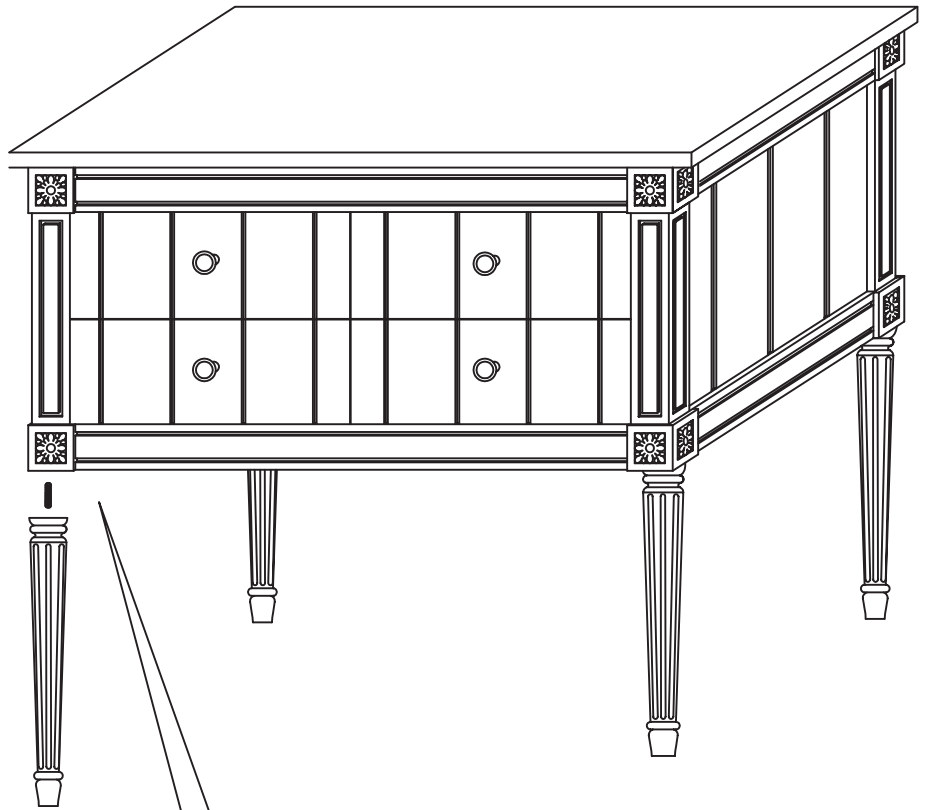
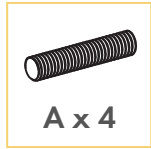

Step 2

Gently lift the storage and place upright on a level surface. Enjoy your new storage!

