

v1.0

# BROSA

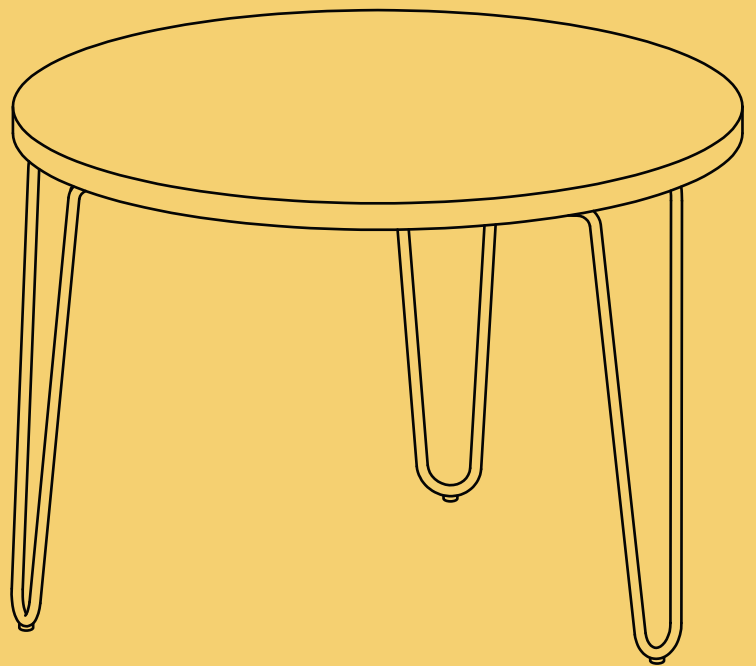

**ASSEMBLY GUIDE**

## Lange Outdoor Side Table

# Components

Before you get started, check you have all of the pieces below. If anything's missing, please visit

[www.brosa.com.au/pages/product-return-and-parts-request](http://www.brosa.com.au/pages/product-return-and-parts-request) and we'll sort it out right away.

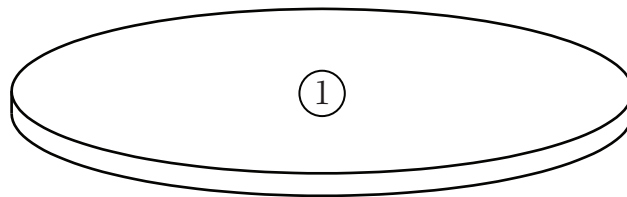
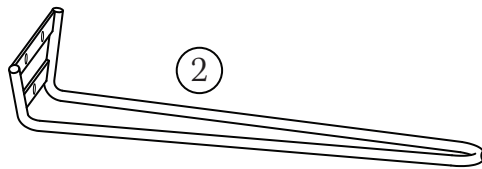
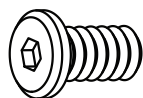

Table Top x 1



Leg x 3

## Hardware



A x 9  
(M6 x 15)



B x 9  
(M6)

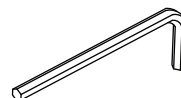

C x 1  
(M4)

## What you need

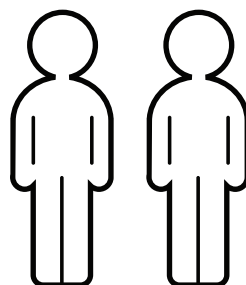

# Step 1

Place the table top (1) on a level surface with the underside facing upward. Align a leg (2) with the underside of the table top so that the bolt holes overlap. Fit a washer (B) to a bolt (A) and then insert the bolt into a hole. Secure the bolt with the Allen key (C) but do not tighten it yet. Repeat this for other holes and then repeat the whole process for the remaining legs.

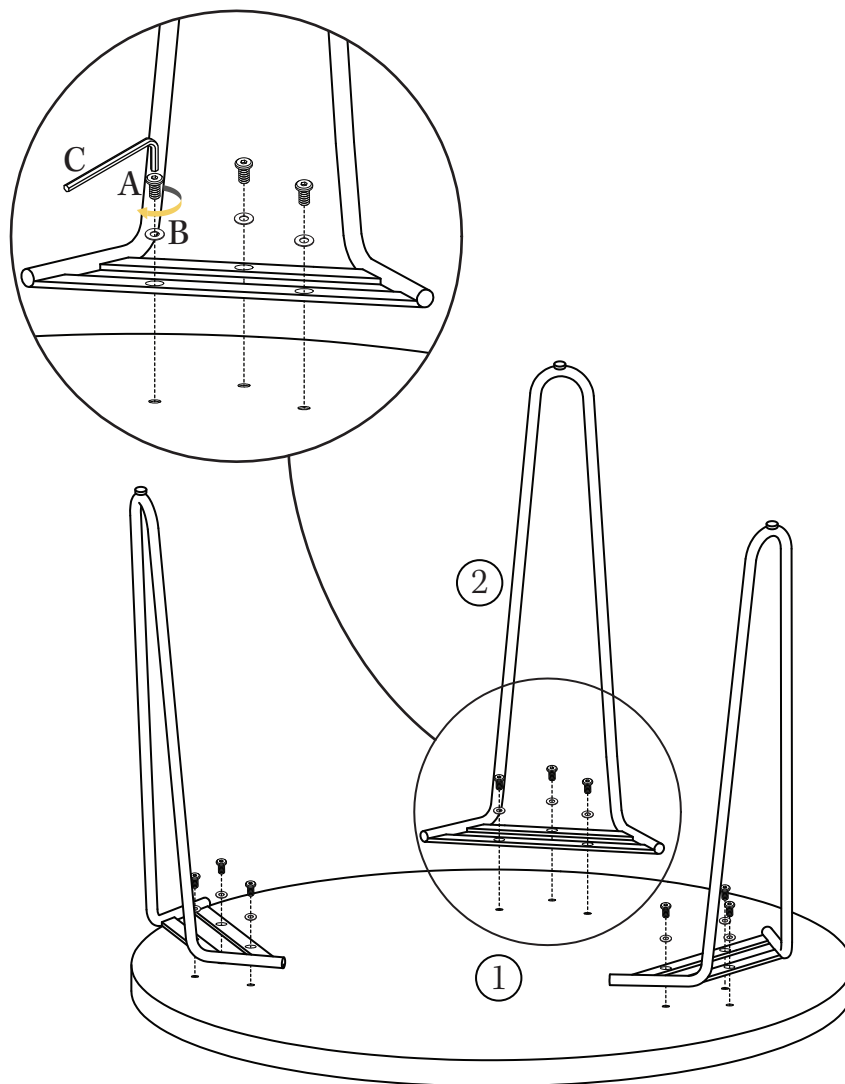

# Step 2

Tighten all bolts using the Allen key (C).

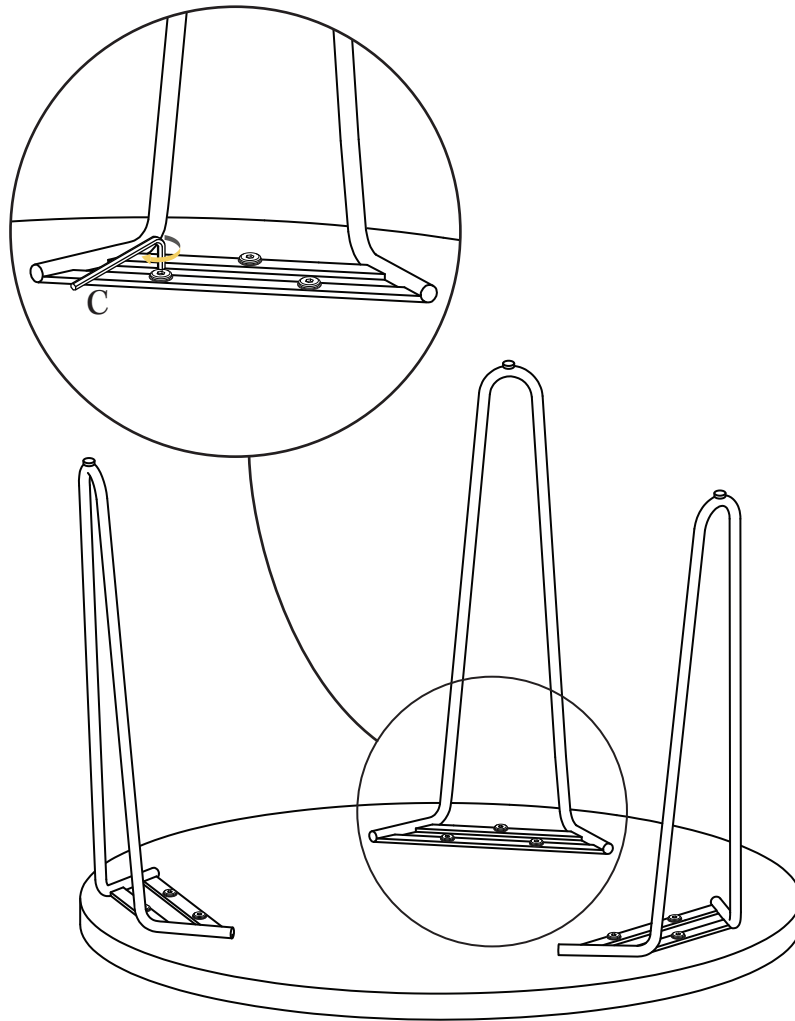

# Step 3

Flip the table and place it upright on a level surface.  
Enjoy your new outdoor side table!

